



# Professional

AUDIO/VISUAL MOUNTING SOLUTIONS

peerless®

# peerless®



With the creation of the industry's first TV Mount in 1964, Peerless leads the way in today's digital environments. Our drive to innovate continues with everything we do. From the very first flat panel mount, to the only precision gear projector mount, to the world's undisputed thinnest flat panel mounts, Peerless delivers form, function and innovation in every product we produce.

In addition to being at the forefront of innovation, Peerless drove the establishment of safety standards for AV mounts over a decade ago with Underwriters Laboratories (UL). Peerless mounts are designed and manufactured in our state-of-the-art facility, giving Peerless full control over production and quality.

## Peerless' pledge

Peerless strives to improve the quality of life for people and the environment around the world. We work together on a daily basis with our suppliers to help create a more sustainable approach to manufacturing professional-quality, professional-grade mounting solutions while minimising our environmental footprint.



Use highest recyclable content materials while maintaining our industry-leading strength and quality



Directive 2002/95/EC compliant to maintain the highest health and safety standards of our customers and environment

## Peerless' dedication

From professional installations into homes, schools and virtually anywhere, to the retail shelf, Peerless offers innovative products for every possible application. Working closely with TV manufacturers, professional installers and integrators, we create mounting solutions that are simple-to-install, offer incredible versatility and are ready for the latest technology and trends. We are dedicated to providing simply the best AV mounting solutions.

## Peerless' commitment

For decades, we have led the industry with the highest levels of safety and quality. Today, millions of Peerless mounts are in use around the world, trusted by professional installers and relied on by consumers.



Setting the standard for safety around the globe



Upholding the highest compatibility standards

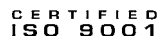

Certified quality in every product

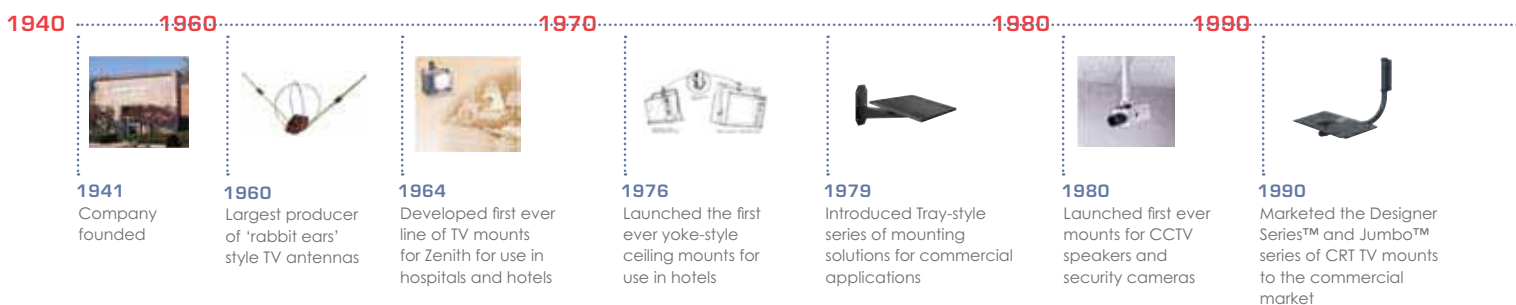

# If you can imagine it, we can create it with Peerless Custom Mounting Solutions



Peerless CMS places the resources of the industry leader in custom mounting solutions at your disposal. Whether your requirement it is a simple modification to a standard Peerless product or a large scale, fully bespoke installation, Peerless CMS has the experience, know-how and facilities to make your solution a reality.

Special customer requests are the very reason why Peerless CMS exists. Through our customer focused D3 process - Design, Develop and Deploy, we work with you from creating the initial concept through to the installation of your solution.

We offer highly trained teams of people who not only understand AV mounts, but also are experienced at serving your market. They are backed by over 40 years of experience.

Peerless is driven by the challenge of unique customer requirements. We have a long history of creating innovative solutions in every Professional Market - from hotels, restaurants, retail stores, hospitals, stadiums, pubs and clubs, schools and universities, we are ready to help you.

When you are thinking about custom mounting solutions, insist on Peerless.

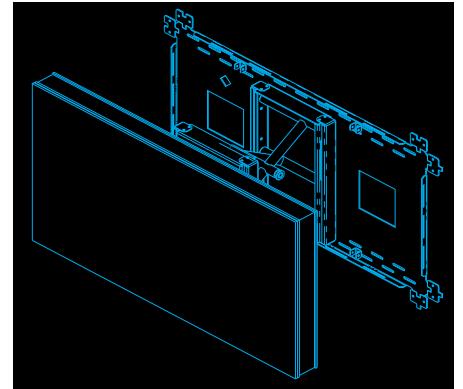

2000



**1993**  
Entered the retail market with our Perfect Mount™ series of CRT TV mounts



**1999**  
Introduced the world's first ever flat panel mount and flat panel trolley



**2003**  
Sold the 2 millionth Jumbo mount in the U.S.



**2006**  
Introduced the industry's first high-gloss series of mounts



**2007**  
Introduced the industry's first ever precision gear projector mount



**2007**  
Launched Paramount™ by Peerless, a comprehensive, value-added range of mounting solutions



**2008**  
Introduced the world's thinnest flat panel mount. At only 8.4 mm (0.33") from the wall, the Slimline® mounts were designed to work with ultra-thin flat panels and support up to 68kg

## Projector mounts



Peerless offers a comprehensive range of projector mounts and accessories for commercial and residential applications. This industry - leading portfolio of projector mount solutions includes the only Precision Gear Projector Mount with ImageLock™ technology, delivering unprecedented accuracy, yet simple and speedy installation.

### Universal projector mounts

PRG Precision Gear projector mount	06
PJF2 projector mount	06
PRS projector mount	07
Paramount flush ceiling projector mount	07

### Projector mounting kits

Ceiling/wall extension mounts	08
Ceiling mount projector kits	08

### Security projector mounts and enclosure

PSM and PSMU security mounts	09
Projector enclosure	09

### Universal short throw projector arms & kits

Universal ultra short throw arms and kits	10
Universal short throw arms and kits	10
Custom mounting solutions	11

## LCD and Plasma mounts



### Wall mounts

SmartMount	12
Paramount	14
Slimline	16
OneMount modular wall mounts	18
Pull out swivel mounts	18
Corner mounts	19
In-wall mounts and boxes	19
Portrait and landscape wall mounts	20
Rotational mount interfaces	20

### Ceiling mounts

Paramount Ceiling mounts for LCD screens	21
Ceiling mounts for LCD/Plasma screens	22

### Multi display ceiling mounts

### Environmental enclosures

### Panel shield

### Desktop mounts

### Stands and trolleys

Trolleys for LCD and Plasma screens	26
Stands with shelving for LCD/Plasma screens	26
Stands for LCD/Plasma screens	27
Pedestal stands for LCD screens	27
Pedestal mounts for LCD/Plasma screens	27

## Peerless MountFinder™

It's the easy way to match the right Peerless mount to a screen. With the ability to search through thousands of flat panel and projector models, users can quickly locate the ideal Peerless mount for their flat panel screen or projector. The most advanced mount compatibility system available, from the company that pioneered the MountFinder™ technology.

Visit [www.peerlessmounts.com](http://www.peerlessmounts.com) to experience the best compatibility tool today.

# AV equipment mounts



Adding value to any installation, Peerless offers a wide range of mounting solutions for additional AV components. Whether you need to integrate a Blu-Ray player with the movement of a Peerless wall mount, get more from a desktop screen or simply keep any cables neat and out of sight, Peerless AV equipment mounts are the answer.

## AV equipment mounts

Adjustable shelves for AV components	28
Adjustable AV component mount	28
AV component mount connector	28
Video conference shelf	28
Cable management channels	28
Universal speaker mounts	28
Camera mount	29
Desktop AV component mount	29
Universal adaptor brackets	29

# Accessories



A comprehensive range of accessories further enhance the function of all Peerless AV mounting solutions. Whether it is a ceiling plate or column, an extra shelf or an additional safety belt for a trolley stand, a Peerless accessory adds value to the mounting solution.

## Accessories

Ceiling plates and adaptors	30
Extension columns	32
Adjustable extension columns	32
Cable management wraps	32
Extension column coupler	32
Thread connector accessory	33
Escutcheon rings	33
Security/safety cables and belts	33
Projector wall arms	34
Side to side adjuster	34
Extension column stabiliser kit	34
Metal stud wall and fastener kits	34
Shelves and arms	34

Know the Manufacturer TV or Projector Model Number?

GO

SEARCH BY MODEL

Step 1. Select Location:

North America (includes Canada and Mexico)
  Europe

Step 2. Select Brand:

- Select Brand -

Step 3. Select Model:

- Select Model -

SEARCH BY BRAND AND MODEL NUMBER

IF YOU DO NOT SEE OR KNOW YOUR MODEL

Search by Screen Size

Small (10"-22")

Medium (23"-39")

Large (40"-60")

X-Large (61+)

See all projector mounts

SEARCH BY SCREEN SIZE

# PRG Precision Gear projector mount

PRG-UNV



- Patent pending precision gear provides ImageLock™ alignment to accurately hold image position, virtually eliminating any sag or drift
- Two adjustment controls for tilt and roll image alignment – engage using a Phillips screwdriver or adjust by hand
- Spider® universal adaptor plate extends up to 448mm to fit most projector models
- Can be flush mounted or used in conjunction with extension poles and plates
- Quick release mechanism to easily service projector
- Horizontal wrench access slots make flush mounting installations quick and easy
- Pre-installed security screws provide optional tilt and roll lock to prevent tampering with adjustment controls
- Cable management allows cables to be routed through projector mount and out of sight
- Available in black, silver (-S) and white (-W) finishes
- Screen specific models available. Please see contact the BBG sales team on +44 (0)1923 205 610

## Technical Specifications

Part No.	Tilt/Pan/Roll	Colour	Max. weight	Mounting pattern
PRG-UNV	±20°, 360°, ±10°	Black	23kg (50lbs)	Universal (up to 448mm)

## Recommended Accessories

- ACC/CMJ**  
ceiling plates – see page 30 - 31
- ADJ/EXT**  
extension poles – see page 32
- PWA-14**  
projector wall arm – see page 34

# PJF2 projector mount

PJF2-UNV



- Single point of adjustment for quick image alignment
- Spider® universal adaptor plate extends up to 448mm to fit most projector models
- Can be flush mounted or used in conjunction with extension poles and plates
- Two thumb screws allow fast projector removal for lamp and filter maintenance
- Cable management allows cables to be routed through projector mount and out of sight
- Includes removable ceiling plate that adapts to any Peerless extension pole
- Available in black and silver (-S) finishes

## Technical Specifications

Part No.	Tilt/Pan/Roll	Colour	Max. weight	Mounting pattern
PJF2-UNV	±15°, 360°, ±15°	Black	23kg (50lbs)	Universal (up to 448mm)

## Recommended Accessories

- ACC/CMJ**  
ceiling plates – see page 30 - 31
- ADJ/EXT**  
extension poles – see page 32
- PWA-14**  
projector wall arm – see page 34

# PRS projector mount

PRS-UNV



- Low profile design allows projector to be close to ceiling
- Spider® universal adaptor plate extends up to 448mm to fit most projector models
- Can be flush mounted or used in conjunction with extension poles and plates
- Quick release mechanism to easily service projector
- Pre-installed security screws provide optional tilt and roll lock to prevent tampering with adjustment controls
- Cable management via access opening allows cables to be routed through projector mount and out of sight
- Available in black, silver (-S) and white (-W) finishes

## Recommended Accessories

- ACC/CMJ**  
ceiling plates – see page 30 - 31
- ADJ/EXT**  
extension poles – see page 32
- PWA-14**  
projector wall arm – see page 34

## Technical Specifications

Part No.	Tilt/Pan/Roll	Colour	Max. weight	Mounting pattern
PRS-UNV	+5°/-20°, 360°, ±10°	Black	11kg (25lbs)	Universal (up to 448mm)

# Flush ceiling projector mount

PARAMOUNT™ by Peerless

PPF



- Low profile design for flush mount installations only
- Provides full range of image adjustment
- Spider® universal adaptor plate extends up to 448mm to fit most projector models
- Available in black, silver (-S) and white (-W) finishes

## Technical Specifications

Part No.	Tilt	Pan	Roll	Colour	Max. weight	Mounting pattern
PPF	+30°/-5°	±20°	±20°	Black	23kg (50lbs)	Universal (up to 448mm)

# Ceiling / wall projector mount with adjustable extension



- Continuous channel design for uninterrupted drop length or wall extension adjustments
- Safety catch designed into extension to ensure user and equipment safety
- Internal cable management within channels for clean and tidy appearance
- Mounts to ceiling or wall (PPA and PPB models)
- Mounts to ceiling (PPC models)
- Spider® universal adaptor plate extends up to 448mm to fit most projector models
- Works with standard 102mm (4") loops for use with round, square, rectangular or I-beam truss up to 76 x 89mm / 3 x 3.5" (w x h)
- Available in black, silver (-S) and white (-W) finishes

### Recommended Accessories

#### ACC575

Allows PPA/PPB/PPC to be attached to standard threaded extensions poles and other ceiling plates - see page 33



Technical Specifications					
Part No.	Ceiling/wall extension	Tilt/Pan/Roll	Max. weight	Colour	Mounting pattern
PPA	324-452mm/253-357mm	+30°/-5°, ±360°, ±20°	23kg (50lbs)	Black	Universal (up to 448mm)
PPB	425-652mm/354-557mm	+30°/-5°, ±360°, ±20°	23kg (50lbs)	Black	Universal (up to 448mm)
PPC	589-962mm (ceiling only)	+30°/-5°, ±360°, ±20°	23kg (50lbs)	Black	Universal (up to 448mm)

## Ceiling mount projector kits



- PRS-UNV or PJP2-UNV universal projector mount together with EXT103 or EXT105 extension column and ACC912 ceiling plate
- EXT103 - 91cm (3') fixed length extension column
- EXT105 - 1.5m (5') fixed length extension column
- ACC912 - lightweight cathedral ceiling adaptor, mounts to cathedral or vaulted ceilings (see page 30)

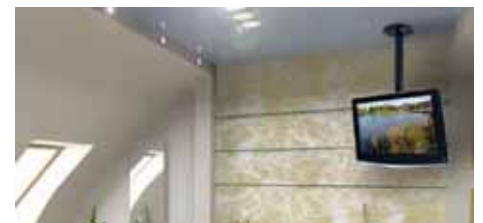

Technical Specifications							
Part No.	Projector mount		Extension column		Ceiling plate	Max. weight	Mounting pattern
PROJKIT100	PRS-UNV	+	EXT103	+	ACC912	11kg (25lbs)	Universal (up to 448mm)
PROJKIT150	PRS-UNV	+	EXT105	+	ACC912	11kg (25lbs)	Universal (up to 448mm)
PROJKIT250	PJP2-UNV	+	EXT105	+	ACC912	23kg (50lbs)	Universal (up to 448mm)

# PSM and PSMU security mounts

PSMU-PRS-S



PSM-UNV-S



- Key-lock security for theft deterrence
- Universal tray pattern accommodates most projectors
- Two piece tray design with barrel key lock prevents access to security fasteners
- Easy access hinge designed for quick projector removal, enabling lamp and filter maintenance
- Top access hole for cable management
- Security fasteners included
- Available in black, silver (-S) and white (-W) finishes



Technical Specifications				
Part No.	Tilt/Pan/Roll	Colour	Max. weight	Mounting pattern
PSM-UNV	±15°, 360°, ±15°	Black	23kg (50lbs)	Universal tray pattern
PSMU-PRS	+5°/-20°, 360°, ±10°	Black	11kg (25lbs)	Universal tray pattern

## Recommended Accessories

- ACC/CMJ**  
ceiling plates – see page 30 - 31
- ADJ/EXT**  
extension poles – see page 32
- PWA-14**  
projector wall arm – see page 34

# Projector enclosure

PE1120-W



Projector mount sold separately - see pages 6 and 7

- For use with projector mounts
- Secures and protects virtually any projector and mount up to 508 x 508 x 28mm (w x d x h)
- Retro-fit capable without altering existing installation
- Simple three-step installation
- Adjustment bars accommodate projector lens placement
- For use with Peerless projector mounts, ceiling plates and extension poles
- 'Hook-n-Hang' feature allows hands-free operation during projector installation or maintenance
- Patented security fasteners and security wrench unique to Peerless
- May be used with a padlock for extra security
- Can also be flush mounted to position projector close to ceiling
- Projector mount purchased separately
- Available in black or white (-W) finish



Part No.	Colour
PE1120	Black

## Recommended Accessories

- PRG, PRS and PJF2**  
projector mounts – see pages 6 - 7

# Universal ultra short throw projector arms and kit



- Sliding carriage design allows projector mount to glide into place at any location on the short throw arm from 0 - 711mm (0 - 28")
- Access slots allow for all internal cable management
- PSTK-028 kit version comes with double stud wall plate and allows 152mm (6") of lateral adjustment for precise alignment of the ultra-short throw projector
- Pre-installed security screws lock down short throw arm and prevent tampering
- Supplied complete with Peerless' Universal Precision Gear Projector Mount (PRG-UNV), featuring patent-pending precision gears that provide exact projector image alignment
- Available in black or white (-W) finishes



Technical Specifications				
Part No.	Tilt/Pan/Roll	Colour	Max. weight	Mounting pattern
PSTA-028	±20°/±15°/±10°	Black	23kg (50lbs)	Universal (up to 448mm)
PSTK-028	±20°/±15°/±10°	Black	23kg (50lbs)	Universal (up to 448mm)

# Universal short throw projector arms and kit



- Telescoping arm design provides a large range of mounting options with convenient lock down at any position
- Telescoping arm extends from 1026 - 1669mm (29 - 55")
- Access slots allow for internal cable management
- PSTK-2995 kit version comes with double stud wall plate and allows 152mm (6") of lateral adjustment for precise alignment of the short throw projector
- Pre-installed security screws lock down short throw arm and prevent tampering
- Supplied complete with Peerless' Universal Precision Gear Projector Mount (PRG-UNV), featuring patent-pending precision gears that provide exact projector image alignment
- Available in black or white (-W) finishes



Technical Specifications				
Part No.	Tilt/Pan/Roll	Colour	Max. weight	Mounting pattern
PSTA-2995	±20°/±15°/±10°	Black	16kg (35lbs)	Universal (up to 448mm)
PSTK-2995	±20°/±15°/±10°	Black	16kg (35lbs)	Universal (up to 448mm)

# Short or ultra short throw...

## peerless® has a custom mounting solution for you

Shown here is a selection of products for the Hitachi CP-A100 ultra short throw projector.  
For solutions to other projectors and interactive white boards, contact the BBG sales team.

### CPA100WALLARM

- Mounts to any flat surface
- Includes horizontal, vertical and front to back adjustments
- Features PRG projector mount



### A100IWBMOUNT

- Spring assisted vertical adjustment allows projector & screen to be raised/lowered together
- Includes horizontal, vertical and front to back adjustments
- Features PRG projector mount



### A100IWBCART

- Works in conjunction with A100IWBMOUNT
- Integrated cable management and locking wheels



For more information contact the BBG sales team on +44 (0)1923 205 610



Simply the most versatile and easy to install mounts, yet packed with clever features, SmartMount represents a complete range of LCD and Plasma screen mounts designed to enhance any professional AV installation.

Be it a pub or club, guestroom, boardroom or classroom, all SmartMount products incorporate intelligent design to add value to a professional AV installation. Many models allow the screen to be displayed in portrait or landscape orientations, ideal for digital signage applications.

SmartMount models are available in a durable black or silver finish to complement today's AV equipment. For the ultimate AV experience – choose SmartMount!

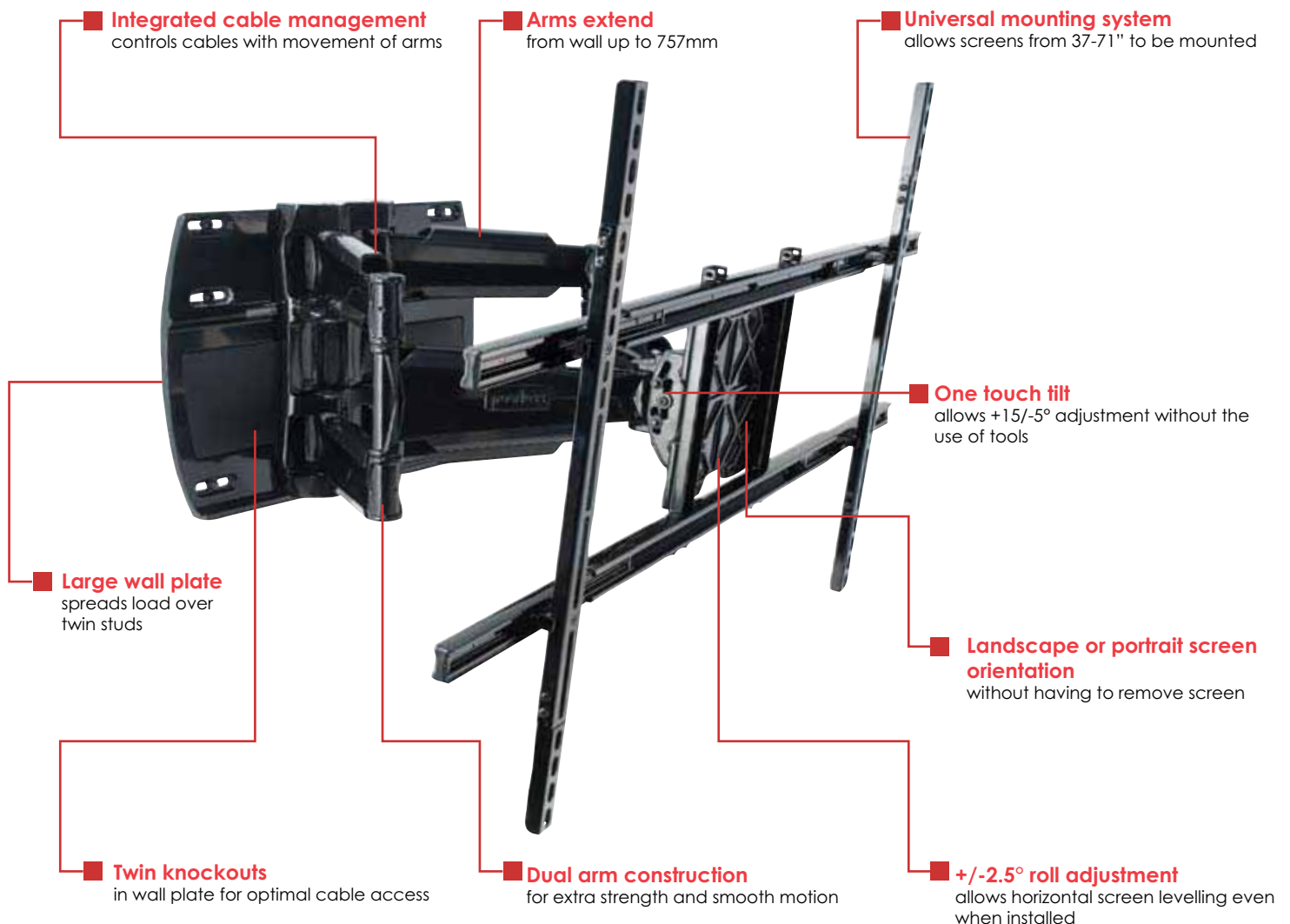

Dimensions & features relate to SA770PU model as shown

## Recommended Accessories

### ACC918



Security fasteners for mounts with VESA® 75, 100, and 200x100 mounting patterns

### ACC919



Security fasteners for mounts with up to VESA® 400x300 mounting patterns

### ACC925



Security fasteners for all scalable wall mounts

	FLAT	TILT	PIVOT	ARTICULATING
<b>SMALL</b> Screen sizes 10-26" LCD	SF630P 	ST630P 	SP730P 	SA730P 
<b>MEDIUM</b> Screen sizes 22-40" LCD	SF632P 	ST632P 	SP740P 	SA740P 
<b>MEDIUM/ LARGE</b> Screen sizes 23-46" LCD	SF640P 	ST640P 	peerless®	
<b>LARGE</b> Screen sizes 32-56" LCD/Plasma	SF650P 	ST650P 	SA745PU (supports 32-52")	
<b>X-LARGE</b> Screen sizes 37-63" LCD/Plasma	SF660P 	ST660P 	SA750PU	
<b>XX-LARGE</b> Screen sizes 42-71" LCD/Plasma	SF670P 	ST670P 	SA770PU	
<b>XXX-LARGE</b> Screen sizes 61-102" LCD/Plasma	SF680P 	ST680P 	peerless®	

All mounts also available in silver (-S)

Part No.	Screen sizes	Max. weight	Tilt	Pan	Roll	Arm extension	Mounting pattern
SF630P	10-26"	36kg (80lbs)	n/a	n/a	n/a	n/a	VESA 75, 100, 200x100
ST630P	10-26"	36kg (80lbs)	+15/-5°	n/a	n/a	n/a	VESA 75, 100, 200x100
SP730P	10-26"	11kg (25lbs)	±35°	±90°	±5°	174mm	VESA 75, 100, 200x100
SA730P	10-26"	11kg (25lbs)	±35°	±90°	±5°	403mm	VESA 75, 100, 200x100
SF632P	22-40"	52kg (115lbs)	n/a	n/a	n/a	n/a	VESA 75, 100, 200x100, 200x200
ST632P	22-40"	52kg (115lbs)	+15/-5°	n/a	n/a	n/a	VESA 75, 100, 200x100, 200x200
SP740P	22-40"	36kg (80lbs)	+15/-5°	±90°	±5°	255mm	VESA 75, 100, 200x100, 200x200
SA740P	22-40"	36kg (80lbs)	+15/-5°	±90°	±7°	513mm	VESA 75, 100, 200x100, 200x200
SF640P	23-46"	68kg (150lbs)	n/a	n/a	n/a	n/a	Universal up to 450x329mm
ST640P	23-46"	68kg (150lbs)	+15/-5°	n/a	n/a	n/a	Universal up to 457x329mm
SF650P	32-56"	80kg (175lbs)	n/a	n/a	n/a	n/a	Universal up to 742x448mm
ST650P	32-56"	80kg (175lbs)	+15/-5°	n/a	n/a	n/a	Universal up to 749x449mm
SA745PU	32-52"	41kg (90lbs)	+15/-5°	±90°	±2.5°	706mm	Universal up to 765x438mm
SF660P	37-63"	91kg (200lbs)	n/a	n/a	n/a	n/a	Universal up to 825x433mm
ST660P	37-63"	91kg (200lbs)	+15/-5°	n/a	n/a	n/a	Universal up to 832x449mm
SA750PU	37-63"	68kg (150lbs)	+15/-5°	±90°	±2.5°	706mm	Universal up to 765x438mm
SF670P	42-71"	113kg (250lbs)	n/a	n/a	n/a	n/a	Universal up to 908x503mm
ST670P	42-71"	113kg (250lbs)	+15/-5°	n/a	n/a	n/a	Universal up to 915x503mm
SA770PU	37-71"	91kg (200lbs)	+15/-5°	±45°	±2.5°	757mm	Universal up to 1096x660mm
SF680	61-102"	159kg (350lbs)	n/a	n/a	n/a	n/a	Universal up to 1111x744mm
ST680	61-102"	159kg (350lbs)	+15/-5°	n/a	n/a	n/a	Universal up to 1119x744mm



With Paramount by Peerless, it couldn't be easier to choose the right mount for your screen... and the great news is that it's even easier to install!

Designed for ease of use and fast intuitive fitting by a professional installer, all Paramount products are finished in a stylish high gloss black to perfectly complement modern LCD and Plasma screens.

If you require a wall mount that is reliable and robust, then look no further than the comprehensive Paramount range.



Dimensions & features relate to PA730 model as shown

## Recommended Accessories

### ACC918



Security fasteners for mounts with VESA® 75, 100, and 200x100 mounting patterns

### ACC919

















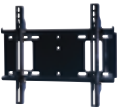

Security fasteners for mounts with up to VESA® 400x300 mounting patterns

### ACC925



Security fasteners for all scalable wall mounts

	FLAT	TILT	FIXED TILT	PIVOT	ARTICULATING
<b>SMALL</b> Screen sizes 10-26" LCD	PF630 	PT630 	peerless®	PP730 	PA730 
<b>MEDIUM</b> Screen sizes 22-40" LCD	PF632 	PT632 	peerless®	PP740 	PA740 
<b>MEDIUM/ LARGE</b> Screen sizes 23-46" LCD	PF640 	PT640 	PFT640 	peerless®	peerless®
<b>LARGE</b> Screen sizes 32-56" LCD/Plasma	PF650 	PT650 	peerless®	PA760 	
<b>X-LARGE</b> Screen sizes 37-60" LCD/Plasma	PF660 	PT660 	PFT660 		

Part No.	Screen sizes	Max. weight	Tilt	Pan	Roll	Arm extension	Mounting pattern
PF630	10-26"	36kg (80lbs)	n/a	n/a	n/a	n/a	VESA 75, 100, 200x100
PT630	10-26"	36kg (80lbs)	+15/-5°	n/a	n/a	n/a	VESA 75, 100, 200x100
PP730	10-26"	11kg (25lbs)	±35°	±90°	±5°	178mm	VESA 75, 100, 200x100
PA730	10-26"	11kg (25lbs)	±35°	±90°	±5°	367mm	VESA 75, 100, 200x100
PF632	22-40"	52kg (115lbs)	n/a	n/a	n/a	n/a	VESA 75, 100, 200x100, 200x200
PT632	22-40"	52kg (115lbs)	+15/-5°	n/a	n/a	n/a	VESA 75, 100, 200x100, 200x200
PP740	22-40"	36kg (80lbs)	+15/-5°	±90°	±7°	207mm	VESA 75, 100, 200x100, 200x200
PA740	22-40"	36kg (80lbs)	+15/-5°	±90°	±7°	396mm	VESA 75, 100, 200x100, 200x200
PF640	23-46"	68kg (150lbs)	n/a	n/a	n/a	n/a	Universal up to 438x329mm
PT640	23-46"	68kg (150lbs)	+15/-5°	n/a	n/a	n/a	Universal up to 446x329mm
PFT640	23-46"	45kg (100lbs)	0, 2, 5 & 10°	n/a	n/a	n/a	Universal up to 453x329mm
PF650	32-56"	80kg (175lbs)	n/a	n/a	n/a	n/a	Universal up to 730x433mm
PT650	32-56"	80kg (175lbs)	+15/-5°	n/a	n/a	n/a	Universal up to 738x449mm
PF660	37-60"	91kg (200lbs)	n/a	n/a	n/a	n/a	Universal up to 730x433mm
PT660	37-60"	91kg (200lbs)	+15/-5°	n/a	n/a	n/a	Universal up to 738x449mm
PFT660	37-60"	80kg (175lbs)	0, 2, 5 & 10°	n/a	n/a	n/a	Universal up to 828x433mm
PA760	37-60"	59kg (130lbs)	+15/-5°	±45°	n/a	410mm	Universal up to 699x432mm

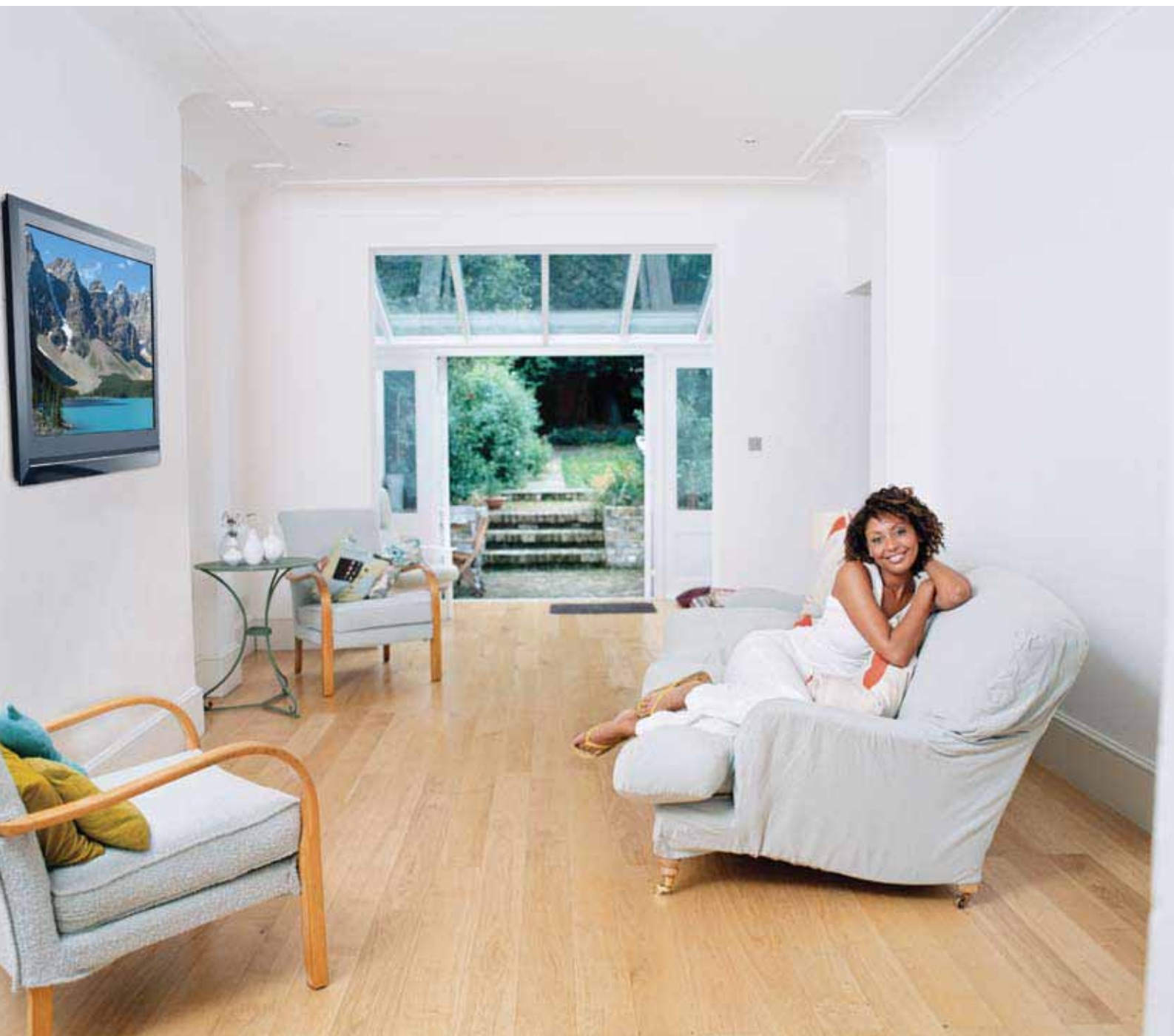

The Slimline range has been specifically designed and developed to complement the very latest ultra thin flat panel screens. Becoming slimmer all the time, these ultra flat screens require a wall mount that positions the screen as close to the wall as possible.

This is the world's thinnest flat panel mounting solution at only 0.84cm – yes, that's only 8.4mm! – making it almost invisible once installed.

The Slimline offers simple fitting, a flexible screen mounting design and secure support - so make a stunning statement with the most discrete wall mount ever developed for your brand new screen.

**Industrial strength Velcro® latching system**  
secures screen adaptors to wall plate in a single step

**Horizontal screen adjustment**  
of up to 203mm (8")

**Universal brackets**  
easily hook onto wall plate for a quick and simple installation

**Ultra-thin design**  
holds screen only 8.4mm (0.33") from the wall for a near-invisible application

**Universal mount**  
compatible with ultra-thin screens with mounting patterns up to 825 x 449mm (32.48 x 17.67")

Dimensions and features relate to SUF660P model as shown



**Recommended Accessories**

**IBA1**



in-wall box for AV accessories – see page 19

Technical Specifications			
Part No.	Screen sizes	Max. weight	Mounting pattern
SUF640P	23-46"	68kg (150lbs)	Universal up to 450x329mm
SUF650P	32-56"	68kg (150lbs)	Universal up to 742x449mm
SUF660P	37-65"	68kg (150lbs)	Universal up to 825x449mm

FLAT	
<b>MEDIUM</b> Screen sizes 23-46"	SUF640P 
<b>MEDIUM/LARGE</b> Screen sizes 32-56"	SUF650P 
<b>LARGE</b> Screen sizes 37-65"	SUF660P 

# ONEMount® modular wall mount

3 - plate configuration



- Modular design expands mount to accommodate 23 to 84" LCD or Plasma screens (one, two or three plate configurations)
- Horizontal screen adjustment up to 203mm (8")
- One touch tilt allows adjustment of +15/-5° without the use of tools with optional tilt lock in 5° increments
- Easy glide design ensures screen is securely attached to wall plate
- Portrait orientation for up to 50" screens (maximum hole pattern of 673x432mm (w x h))
- Supplied with M10 screen adaptors for complete screen compatibility
- Available in black or silver (-S) finish



## Recommended Accessories

**ACC925**  
Security fasteners



## Technical Specifications

Part No.	Screen Size	Colour	Max. weight	Mounting pattern
ONE-TP	23-84"	Black	113kg (250lbs)	Universal up to 1036x673mm

# Pull-out swivel wall mounts



- Ideal product for digital signage and hospitality applications (i.e. video wall) where screen must be recessed
- Suited for LCD & Plasma screens from 32 to 58"
- Arms extend up to 273mm (10.25") from wall
- Pull-out swivel with up to 90° rotation (±45° left or right)
- 0, 5 or 10° lockable tilt
- Integrated cable management
- ±1° roll for horizontal screen alignment during installation
- Locking tab included for optional swivel restriction to one side
- Lock Key™ installation tool securely extends arms for screen installation
- Available in high gloss black or silver finish (-S)



## Technical Specifications

Part No.	Screen Size	Colour	Max. weight	Mounting pattern
SP850-UNL	32-58"	Black	68kg (150lbs)	Universal up to 729x432mm

# Corner mounts

CM850



CM50



CM60



- Allows screen to fit in a corner where space is limited
- CM850 model includes SP850-UNL pull-out swivel mount – (see page 18 for full details)
- CM50 wall units expand to support compatible flat-to-wall or tilting wall mounts for LCD and Plasma screens 32-50" in size (sold separately)
- CM60 includes additional support plate to accommodate compatible flat-to-wall or tilting wall mounts for LCD and Plasma screens 40-60" in size
- Wall units accommodate speakers when used with smaller screens (wall unit may be visible with some smaller screens)
- Optional shelf (ACC324) available for AV components



Technical Specifications				
Part No.	Screen Size	Colour	Max. weight	Mounting pattern
CM850	32-58"	Black	68kg (150lbs)	Universal up to 729x432mm
CM50	32-50"	Black	79kg (175lbs)	Requires wall mount (sold separately)
CM60	40-60"	Black	91kg (200lbs)	Requires wall mount (sold separately)

Recommended Accessories	
<p><b>ACC324</b> Corner mount shelf see page 34</p>	

# In-wall mounts and boxes

IM740P

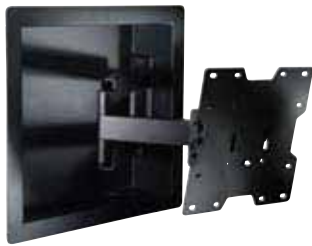

IM760PU



## In-wall mounts (IM740/760)

- Installs between 16" wood stud centres
- Stud locating tabs adjust 6.35mm (1/4") left or right to accommodate stud spacing
- IM740P model includes SA740P articulating mount for up to 40" LCD screens (see page 13)
- IM760PU models mount up to 71" LCD or plasma screens
- Removable mains plug cover and cable management access plates make installation simple
- Black finish

## In-wall boxes for wall mounts (IB40)

- Compatible with small (10-26") and medium (22-40") pivoting and articulating arm mounts
- Installs between 16" wood stud centres
- Stud locating tabs adjust 6.35mm (1/4") left or right to accommodate stud spacing
- Removable mains plug cover and cable management access plates make installation simple
- Three height adjustment points in box to set vertical screen position
- Can be inverted to position screen to the left or right
- Box only - screen mount sold separately
- Available in high gloss black, silver (-S) or white (-W) finishes

IB40



IBA1



## In-wall box for AV accessories (IBA1)

- Installs between 16" or larger stud centres
- Removable mains outlet cover and cable management access plates make on top and bottom
- Helps to create a clean and near invisible installation by adding additional cable and accessory management space behind the screen
- Can be mounted horizontally or vertically for optimal positioning

Technical Specifications				
Part No.	Screen Size	Colour	Max. weight	Mounting pattern
IM740P	22-40"	Black	36kg (80lbs)	VESA 75/100/200x100/200x200
IM760PU	32-71"	Black	91kg (200lbs)	Universal up to 729x432mm
IB40	Up to 40"	Black	36kg (80lbs)	Screen mount sold separately
IBA1	n/a	Black	11kg (25lbs)	n/a

# Portrait and landscape wall mounts

SF16D



ST16D



PLP-UN-1



## Flat to wall - SF16D

- For use with PLP-UN1 universal bracket ideally suited for flat panel screens 32-50", up to 57kg in weight (not included)
- PLP-UN1 adaptor may be installed in portrait or landscape orientation, accommodating up to 701x400mm mounting pattern
- Measures 30mm from wall plus thickness of adaptor plate
- Horizontal screen adjustment of up to 15cm (6")
- Easy glide design ensures screen is securely attached to wall plate
- Supplied with 489mm (19.25") wide wall plate, ideal for portrait style installations
- Includes theft resistant hardware for attaching screen to mount
- Black finish

## Tilting - ST16D

- For use with PLP-UN1 universal bracket ideally suited for flat panel screens 32-50", up to 57kg in weight (not included)
- PLP-UN1 adaptor may be installed in portrait or landscape orientation, accommodating up to 701x400mm mounting pattern
- One touch tilt allows adjustment of +15/-5° without the use of tools with optional tilt lock in 5° increments
- Measures 76mm (3") from wall plus thickness of adaptor plate
- Horizontal screen adjustment of up to 20cm (8")
- Easy glide design ensures screen is securely attached to wall plate
- Supplied with 489mm (19.25") wide wall plate, ideal for portrait style installations
- Black finish

Technical Specifications			
Part No.	Screen Size	Max. weight	Mounting pattern
SF16D	32-50"	57kg (125lbs)	Universal up to 701 x 400mm
ST16D	32-50"	57kg (125lbs)	Universal up to 701 x 400mm
PLP-UN-1	32-50"	57kg (125lbs)	Universal up to 701 x 400mm

## Rotational mount interface

- For use with wall and ceiling mounts, stands\* and trolleys\*
- Allows flat panel to be rotated 360° without removing the screen from the mount, locking the screen's roll angle in 15° increments
- Spring loaded handle for easy screen position adjustment
- Black finish

\* Requires ACC170 (see right)



## Recommended Accessories

### ACC170

Rotational mount interface



- Rotational mount interface for SS550P stand and SR560 trolley (see page 26)
- Black finish

Technical Specifications			
Part No.	Colour	For use with	Max. weight
RM1	Black	Mounts, stands, trolleys	n/a

# Ceiling mounts for LCD screens



- PC930 models: VESA 75 and 100 compliant for LCD screens 15-24"
- PC932 models: VESA 75, 100, 200x100mm and 200x200mm compliant for LCD screens 15-37"
- Ideal for flat finished concrete or wood joist ceilings
- Adjustable extension length (see table below)
- Continuous tilt of +15°/-5° with optional lock in 5° increments
- Internal cable management within extension channels for clean, clutter free appearance
- Safety catch designed into extension channels to ensure user and equipment safety
- Works with standard 102mm (4") loops for use with round, square, rectangular or I-beam truss up to 76 x 89mm (3 x 3.5")
- Available in black, silver (-S) or white (-W) finishes



	Ceiling mount extension length		
	246-353mm (9.7-13.9")	350-556mm (13.8-21.9")	514-864mm (20.2-34")
<b>SMALL</b> 15-24"	PC930A	PC930B	PC930C
<b>Medium</b> 15-37"	PC932A	PC932B	PC932C

**Recommended Accessories**

**ACC575**  
Allows PPA/PPB/PPC to be attached to standard threaded extensions poles and other ceiling plates - see page 33

Technical Specifications					
Part No.	Screen sizes	Extension	Colour	Max. weight	Mounting pattern
PC930A	15-24"	246-353mm (9.7-13.9")	Black	23kg (50lbs)	VESA 75, 100
PC930B	15-24"	350-556mm (13.8-21.9")	Black	23kg (50lbs)	VESA 75, 100
PC930C	15-24"	514-864mm (20.2-34")	Black	23kg (50lbs)	VESA 75, 100
PC932A	15-37"	246-353mm (9.7-13.9")	Black	36kg (80lbs)	VESA 75, 100, 200x100, 200x200
PC932B	15-37"	350-556mm (13.8-21.9")	Black	36kg (80lbs)	VESA 75, 100, 200x100, 200x200
PC932C	15-37"	514-864mm (20.2-34")	Black	36kg (80lbs)	VESA 75, 100, 200x100, 200x200

# Ceiling mounts for LCD/Plasma screens



## Universal single screen ceiling mount

- Universal mount for landscape mounting LCD or Plasma screen
- Supplied with structural ceiling plate
- Extends centre of screen 108cm (42.63") from ceiling
- Suitable for 32-60" size screens
- 20° tilt, 360° pan
- For mounting to wood joists on 400-440mm centres or concrete ceiling



Technical Specifications				
Part No.	Screen Size	Colour	Max. weight	Mounting pattern
PLCM-UNL-CP	32-60"	Black	91kg (200lbs)	Universal up to 729x433mm

## Recommended Accessories

**ACC, CMJ, DCS & DCT**  
ceiling plates – see pages 30 - 31  
**EXT & ADJ**  
ceiling extensions – see page 32

# Ceiling mounts for LCD/Plasma screens

PLCM-2



PLB-1



- Entire unit pans 360° with stop feature
- 20° adjustable tilt
- Screens can be mounted in portrait or landscape orientation
- Requires extension pole adaptor and ceiling plate, each sold separately
- **PLCM-2**: suitable for 32-60" LCD or Plasma screen
- **PLB-1**: Suitable for two 32-50" LCD or Plasma screen (both screens recommended to be the same size)



Technical Specifications				
Part No.	Screen Size	Colour	Max. weight	Mounting pattern
PLB-1	32-50"	Black	136kg (300lbs)	Screen adaptor sold separately
PLCM-2	32-60"	Black	102kg (225lbs)	Screen adaptor sold separately

## Recommended Accessories

**ACC, CMJ, DCS & DCT**  
ceiling plates – see pages 30 - 31  
**EXT & ADJ**  
ceiling extensions – see page 32  
**PLP-UNL/PLP-UNM/PLP-UN-1**  
universal adaptor brackets – see page 29

# Multi display ceiling mounts

A fully modular system for mounting multiple flat panel displays, the Peerless Multi Display system allows you to ceiling mount up to four LCD or Plasma screens in a variety of configurations. Whether your requirement is for an in-line, circular or curved array of displays, Peerless have the solution.

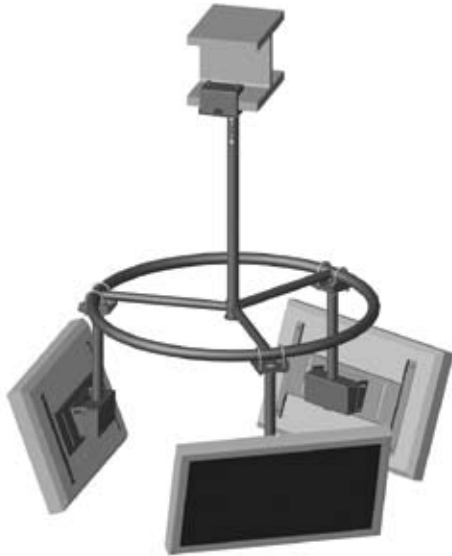

Circular configuration

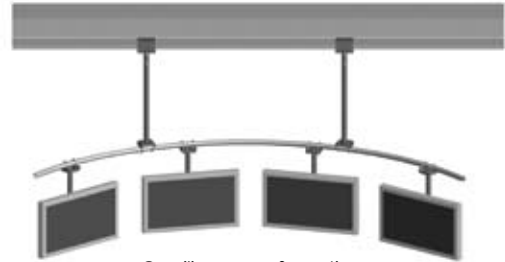

Curvilinear configuration

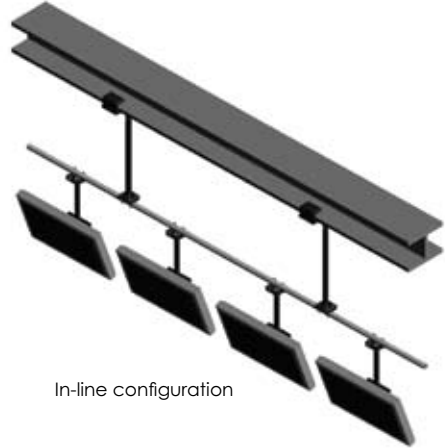

In-line configuration

For more information contact the BBG sales team on +44 (0)1923 205 610

## Environmental enclosures

Protect your flat panel display from the rain, snow, dust and potential vandalism with the Peerless Environmental Enclosure. Ideal for digital signage applications, the enclosure has been specifically designed for use in public areas. Available with climate control features for either indoor or outdoor environments. Solid metal construction ensures high levels of security.



For more information contact the BBG sales team on +44 (0)1923 205 610

## Panel Shield™ LCD & Plasma screen cover

The Panel Shield from Peerless protects and enhances the appearance of any 40/42" LCD or Plasma flat panel display. The Panel Shield features a tough aluminium surround and protective polycarbonate window to prevent accessing the display's controls or splashing liquids on the screen surface. Ideal for digital signage applications, the Panel Shield can be customised with a logo or message.



For more information contact the BBG sales team on +44 (0)1923 205 610

## Height adjustable desktop mount for LCD screens

- Suitable for desk mounting LCD screens 10-22" in size
- 360° pan, 30° adjustable backward or forward tilt
- Height adjustment allows the screen to travel 241mm (9.5") up and down arm and tightens into place
- Bolts to wood/wood composite surfaces 19 to 38mm thick
- VESA 75 and 100 compliant
- Silver finish



### Technical Specifications

Part No.	Screen Size	Max. weight	Mounting pattern
LCV-100	10-22"	11kg (25lbs)	VESA 75, 100

## Extendable desktop mounts for LCD screens

- Suitable for desk mounting LCD screens 10-22" in size
- Side to side panning can be restricted to  $\pm 45^\circ$  or less
- 50° upward and 30° downward tilt
- Height adjustable in four 25mm (1") increments from 312 to 414mm (12.3-16.3")
- Supplied with external clips for cable management
- VESA 75 and 100 compliant
- Available in black or grey (G) finish



LCH-100G



LCH-100

### Technical Specifications

Part No.	Screen Size	Max. weight	Mounting pattern
LCH-100	10-22"	11kg (25lbs)	VESA 75, 100

## Tabletop stand

- Ideal for 32-50" LCD and Plasma screens
- Base can be set in a fixed position or rotate up to 360°
- 10° forward and 5° backward tilt
- Cable management keeps cables out of the way for a clean and tidy appearance
- Base finished in black graphite laminate
- Felt padding on underside of base protects tabletop surface
- Requires PLP-UNL adaptor (sold separately)



### Technical Specifications

Part No.	Screen Size	Max. weight	Mounting pattern
PLT-BLK	32-50"	68kg (150lbs)	Adaptor sold separately

## Desktop swivel mount for LCD screens

- Ideally suited for LCD screens 22-40" in size
- 30° of swivel to each side (60° in total)
- Height adjustment from 399mm to 553mm, adjustable in 38mm (1.5") increments
- Bolt down mount for secure attachment
- Supplied with security screws
- Accommodates VESA® 100, 200x100 and 200x200 mounting patterns
- Maximum load capacity 36kg (80lbs)
- Available in black, gloss black (-GB) or silver (-S) finishes



### Technical Specifications

Part No.	Screen Size	Max. weight	Mounting pattern
HP432-002	22-40"	36kg (80lbs)	VESA 100, 200x100 and 200x200

## Articulating desktop mount for LCD screens

- Suitable for desk mounting LCD screens 10-22" in size
- Three pivot points with up to 360° pan, ±60° tilt
- Includes extension arm
- Mounting options for all surfaces (desk clamp and desk bolt) included
- Up to 360° roll adjustment allows screen to be displayed in landscape or portrait orientation
- Compact retractable design increases workspace
- Durable gas strut and ball-joint system for smooth, stable operation
- Die cast aluminium construction
- Black finish



### Technical Specifications

Part No.	Screen Size	Max. weight	Mounting pattern
LCT-101	10-22"	11kg (25lbs)	VESA 75, 100

## Desktop LCD twin screen mount

- Suitable for desk mounting two LCD screens 10-22" in size
- Adjustable crosswing and ball joint design allows maximum screen fitting flexibility
- Ball joint system delivers individual screen pan, tilt and rotation adjustment
- Supports LCD screens up to 11kg (25lbs) per screen
- Mounting options for all surfaces – clamp, bolt and free-standing desk base (each sold separately)
- Integrated cable management for a clean and tidy appearance
- Strong and attractively styled die cast aluminium construction
- Black finish



### Recommended Accessories



### Technical Specifications

Part No.	Screen Size	Max. weight	Mounting pattern
LCT-102	2 x 10-22"	2 x 11kg (25lbs)	VESA 75, 100

## Desktop LCD triple screen mount

- Suitable for desk mounting three LCD screens 10-22" in size
- Adjustable crosswing and ball joint design allows maximum screen fitting flexibility
- Ball joint system delivers maximum individual screen pan, tilt and rotation adjustment
- Supports LCD screens up to 11kg (25lbs) per screen
- Mounting options for all surfaces – clamp, bolt and free-standing desk base (each sold separately)
- Integrated cable management for a clean and tidy appearance
- Strong and attractively styled die cast aluminium construction
- Black finish



### Recommended Accessories



### Technical Specifications

Part No.	Screen Size	Max. weight	Mounting pattern
LCT-103	3 x 10-22"	3 x 11kg (25lbs)	VESA 75, 100

## Desktop LCD quad mount

- Suitable for desk mounting four LCD screens 10-22" in size
- Adjustable twin crosswing and ball joint design allows maximum screen fitting flexibility
- Ball joint system delivers maximum individual screen pan, tilt and rotation adjustment
- Supports LCD screens up to 11kg (25lbs) per screen
- Mounting options for all surfaces – clamp, bolt and free-standing desk base (each sold separately)
- Integrated cable management for a clean and tidy appearance
- Strong and attractively styled die cast aluminium construction
- Black finish



### Recommended Accessories



### Technical Specifications

Part No.	Screen Size	Max. weight	Mounting pattern
LCT-104	4 x 10-22"	4 x 11kg (25lbs)	VESA 75, 100

# Trolleys for LCD and Plasma screens



- Ideally suited for 32-60" LCD and Plasma screens
- Incremental tilt angle (-2, 0, +5°) together with continuous height adjustment on 1.66m (65") column for optimum viewing position
- 100mm swivel castors allow for easy movement and trolley positioning (two locking castors)
- Adjustable tempered glass (SR560G) or metal shelf (SR560M) to hold AV equipment and accessories
- Internal cable management for a clean and tidy appearance
- Black finish
- Total maximum load (screen + shelves) 114kg (250lbs)

## Recommended Accessories

- ACC310** Levelling feet
- ACC313** Metal shelf - page 35
- ACC314** Laptop arm - page 35
- ACC315** Base shelf - page 35
- ACC316** Safety belt for slotted shelf - page 33
- ACC318** Tempered glass shelf - page 33
- ACC319** Video conferencing shelf - page 35

## Technical Specifications

Part No.	Screen size	Shelf	Stand colour	Max. weight	Mounting pattern
SR560G	32-60"	Glass	Black	68kg (150lbs) screen, 23kg (50lbs) per shelf	Universal up to 730x433mm
SR560M	32-60"	Metal	Black	68kg (150lbs) screen, 23kg (50lbs) per shelf	Universal up to 730x433mm

# Stands with shelving for LCD/Plasma screens



- Designed to complement the look of any room
- Incremental tilt angle (-2, 0, +5°) together with continuous height adjustment on 1.46m (57.6") column for optimum viewing position
- Adjustable tempered glass shelves to support AV equipment and accessories
- Internal cable management hides all connecting cables for a clean and tidy appearance
- Stand available in high gloss black or silver (-S) finishes
- Total maximum load (screen + shelves) 114kg (250lbs)
- Available in black or silver (-S) finish

## Recommended Accessories

- ACC318/-S/-GB**  
Tempered glass shelves – see page 35

## Technical Specifications

Part No.	Screen size	Shelves	Stand colour	Max. weight	Mounting pattern
SS550P	32-50"	2 x tinted shelves	Black	68kg (150lbs) screen, 23kg (50lbs) per shelf	Universal up to 730x433mm
SGLB01	32-50"	1 x clear shelf	Black	68kg (150lbs) screen, 23kg (50lbs) per shelf	Universal up to 730x433mm

# Stands for LCD/Plasma screens



- Ideally suited for 32-60" (FPZ-600) or 50-71" (FPZ-670) LCD and Plasma screens
- VESA 100, 200x100mm and 200x200mm compliant
- Supports non VESA screens with additional PLP screen adaptor (sold separately)
- Internal cable management for a clean and tidy appearance
- Height adjustable on 1.8m (6') poles
- Screen(s) can be positioned in landscape or portrait orientation
- Hook-on design allows screen to rest in place while screen is being secured
- FPZ-600: fits single or back-to-back LCD or Plasma screens (up to four screens with additional ACC604 cartridge, sold separately)
- FPZ-670 fits two 50-71" screens back-to-back with base cover designed to conceal AV source, surge protector etc.
- Black finish

Technical Specifications				
Part No.	Screen Size	Colour	Max. weight	Mounting pattern
FPZ-600	32-60"	Black	91 kg (200lbs) per screen up to 4 screens	VESA 100, 200x100, 200x200. Universal screen adaptor sold separately
FPZ-670	50-71"	Black	91 kg (200lbs) per screen up to 2 screens	VESA 100, 200x100, 200x200. Universal screen adaptor sold separately

## Recommended Accessories

**ACC604**



**PLP-UNL/PLP-UN-1**  
universal adaptor brackets – see page 29

## Pedestal stands for LCD screens

- Ideally suited for 10-30" LCD screens
- VESA 75 and 100 compliant
- Adjustable height from 1.5 to 2m (60.75-80")
- Feet can move inward along tubular structure if required
- ±90° pan left or right (180° total) at the stand head
- Can be used freestanding (up to 11kg/25lbs) or bolted down (up to 18kg/40lbs)
- Complete with fittings to bolt to concrete flooring
- Available in black or silver (-S) finish



Technical Specifications				
Part No.	Screen Size	Colour	Max. weight	Mounting pattern
LCFS-100	10-30"	Black	11kg (25lbs) freestanding 18kg (40lbs) bolted down	VESA 75, 100

## Pedestal mounts for LCD and Plasma screens

- Choice of 1.8m (COL610P) or 2.4m (COL810P) pedestal height
- 15° forward tilt for viewing flexibility
- 360° pan with swivel stop
- Screen can be changed from landscape to portrait orientation without having to remove the screen
- Internal cable management
- Concrete floor anchors included
- Requires screen adaptor (sold separately)



## Recommended Accessories

**ACC833**  
Equipment accessory shelf  
- see page 35

**PLP-UNL/PLP-UN-1**  
universal adaptor brackets  
- see page 29

Technical Specifications				
Part No.	Screen Size	Colour	Max. weight	Mounting pattern
COL610P	32-50"	Black	68kg (150lbs)	Adaptor sold separately
COL810P	32-50"	Black	68kg (150lbs)	Adaptor sold separately

## Adjustable shelf for AV components



- Versatile design ideal for stacking multiple AV components
- Adjustable width and depth
- Snap-on cover hides wall plate and mounting hardware
- Adjustment control allows for simple levelling of components
- Embossed arms with screw holes secure components to shelf
- 45kg load capacity allows stacking of multiple components
- Black finish

Technical Specifications			
Part No.	Colour	Max. weight	Width range, depth range
PS200	Black	45kg (100lbs)	405-468mm, 377-584mm

## Adjustable AV component mounts

- Accommodates most front loading AV components
- Adjustable height and width
- Units can be stacked without additional accessories
- For use with ACC931 and ACC932
- Available in black or silver (-S)

\* When stacking units do not exceed the load capacity of the TV mount and the maximum load capacity of 23kg (combined weight of AV component together with component mount)



Technical Specifications			
Part No.	Colour	Max. weight*	Width range, height range
DS25	Black	23kg (50lbs)	337-438mm, 38-70mm
DS35	Black	23kg (50lbs)	260-362mm, 68-114mm
DS40	Black	23kg (50lbs)	337-438mm, 68-114mm
DS45	Black	23kg (50lbs)	337-438mm, 108-146mm

## AV component mount connector

- Connects Peerless articulating, pivoting and ceiling mounts to AV component mounts DS25/35/40/45 (sold separately)
- Can be installed without removing mount from wall
- Adjustable height allows AV equipment to sit flush with TV
- Available in black or silver (-S)



Technical Specifications			
Part No.	Colour	Max. weight	For mounts with
ACC931	Black	14kg (30lbs)	PLP adaptor plates
ACC932	Black	14kg (30lbs)	VESA 75, 100, 200x100 & 200x200mm mounting pattern

## Video conference shelf



- Mounts to 16-24" wood studs
- Shelf can be installed above or below LCD or Plasma screen
- 102mm (4") of adjustable height for optimum placement of video conferencing equipment
- Includes fittings for wood stud mounting
- Black finish

Technical Specifications			
Part No.	Colour	Max. weight	Dimensions (w x d)
ACC309	Black	11kg (25lbs)	626 x 198mm

## Cable management channels

- Keeps cables and power cords out of sight for a clean and professional appearance
- Paintable surface to match any environment
- 1.4m (4.5') long with the ability to be customised to desired length
- Measures 27mm (1.05") from wall for a low profile installation
- 90° corner connector to route cables to the side
- Wall attachment clips designed with integrated channels to keep cables in place
- Available in black or white (-W)



Technical Specifications		
Part No.	Colour	Dimensions (w x d x h)
PCC	Black	79 x 27 x 1371mm

## Universal speaker mounts

PARAMOUNT™ by Peerless

- Mounts to wall or ceiling
- Universal design fits most brands
- Simple tilt, pivot and rotation adjustment
- Includes 57mm (2.25") ceiling extension
- 1, 2 and 4 hole mounting adaptors accommodate speakers with keyhole and threaded inserts
- Includes installation and speaker attachment fittings
- Also available in white (-W)



- Available in pairs (PSP2) or pack of 5 (PSP5)

Technical Specifications				
Part No.	Colour	Tilt, Pan, Roll	Max. weight	Mounting pattern
PSP2	Black	±90°, 360°, 360°	3.6kg (8lbs)	Universal - fits most brands
PSP5	Black	±90°, 360°, 360°	3.6kg (8lbs)	Universal - fits most brands

## Universal mounts for speakers up to 9kg

- Ball and socket design provides 60° rotation in any direction
- Concealed mounting screws
- Flush mounted or for use with 75mm (3") extensions
- Includes fittings for mounting most commercially available speakers
- Includes fasteners for wood studs, metal studs, concrete and drywall
- Internal speaker cable management
- Also available in white (-W)



### Technical Specifications

Part No.	Colour	Tilt, Pan, Roll	Max. weight	Mounting pattern
SPK811	Black	±60°, 360°, ±60°	9kg (20lbs)	Universal - fits most brands

## Universal mount for speakers up to 34kg

- Mounting plates have 102x102mm (4x4") cut-out for speaker cable access
- Up to ±45° pivot in vertical and horizontal planes
- Heavy gauge cold rolled steel construction
- Requires wall installation hardware (sold separately)



### Technical Specifications

Part No.	Colour	Tilt, Pan	Max. weight	Mounting pattern
SPK815	Black/White	±45°, ±45°	34kg (75lbs)	Universal - fits most brands

## Camera mount

- Ball and socket for 360° pan and 90° tilt for positioning direction of camera
- 178mm (7") arm extension
- Can be wall or ceiling mounted
- Engineered plastic eliminates electrical grounding problems
- Single point adjustment control
- Cable management routing channel
- Patented design



### Technical Specifications

Part No.	Colour	Tilt, Pan	Max. weight
CMR410	Light grey	90°, 360°	4.5kg (10lbs)

## Desktop AV component mount

- Two piece tray with security fasteners and key lock
- Tray hole pattern fits most AV components
- Holds equipment in fixed position
- Black finish



### Technical Specifications

Part No.	Colour	Max. weight	Dimensions
LDM233K	Black	18kg (40lbs)	432 x 305mm

## Universal adaptor brackets for LCD/Plasma screens

- Compatible with most Peerless LCD/Plasma mounts (sold separately)
- Easy glide design ensures screen is securely attached to wall plate
- Durable heavy gauge steel construction
- Available in black or silver (-S) finish



PLP-UNM



PLP-UNL

### Technical Specifications

Part No.	Screen size	Colour	Max weight	Mounting pattern
PLP-UNM	23-46" LCD	Black	68kg (150lbs)	Universal up to 438 x 329mm
PLP-UNL	32-60" LCD/Plasma	Black	91kg (200lbs)	Universal up to 729 x 433mm

## Portrait/Landscape universal adaptor for LCD/Plasma screens

- Sliding bracket design ideally suited for use with screens 32-50"
- Compatible with most Peerless LCD/Plasma mounts (sold separately)
- Supplied with security fasteners
- Durable heavy gauge steel construction

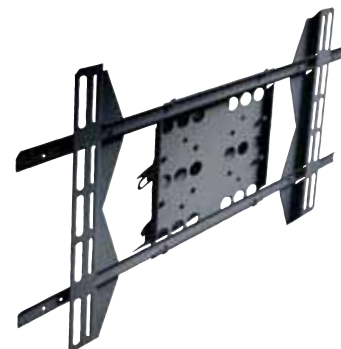

### Technical Specifications

Part No.	Screen size	Colour	Max weight	Mounting pattern
PLP-UN-1	32-50"	Black	57kg (125lbs)	Universal up to 701 x 400mm

## Ceiling plate for wood joists

- Mounts to wood joists on 400-440mm centres or structural concrete ceiling (requires concrete wall plugs, sold separately)
- For use with Peerless ceiling mounts & projector mounts
- Compatible with Peerless extension poles
- Black finish



### Technical Specifications

Part No.	Colour	Max. weight	Mounting pattern
CMJ470	Black	136kg (300lbs)	16" joist centres

## Round ceiling plate

- Mounts to wood joist or structural ceiling
- Cable management access hole
- For use with Peerless ceiling mounts & projector mounts
- Compatible with Peerless extension poles
- Available in black, silver (-S) and white (-W) finishes



### Technical Specifications

Part No.	Colour	Max. weight
ACC570	Black	68kg (150lbs)

## Structural ceiling plate

- Mounts to wood joists, structural ceiling or concrete
- Low profile design ideal for small screens and projector installations
- For use with Peerless ceiling mounts & projector mounts
- Compatible with Peerless extension poles
- Black finish



### Technical Specifications

Part No.	Colour	Max. weight
ACC560	Black	23kg (50lbs)

## Cathedral ceiling plate

- Mounts to cathedral or vaulted ceilings
- 120° (±60°) of adjustment
- **ACC556**: heavy duty for up to 136kg (300lbs), available in white
- **ACC912**: compact, lightweight design handles up to 34kg (75lbs)

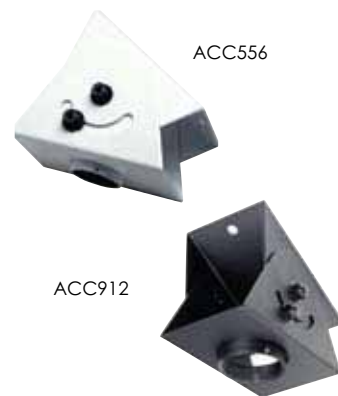

### Technical Specifications

Part No.	Colour	Max. weight
ACC556	White	136kg (300lbs)
ACC912	Black	34kg (75lbs)

## Anti-vibration ceiling plates

- Reduces vibrations that may cause internal damage to equipment and/or cause screen image to vibrate
- Features two cable management access holes
- For use with Peerless ceiling mounts & projector mounts
- Compatible with Peerless extension poles
- **ACC840**: for wood joist ceiling
- **ACC845**: for Unistrut® ceiling
- Black finish



### Technical Specifications

Part No.	Colour	Max. weight	Mounting pattern
ACC840	Black	27kg (60lbs)	n/a
ACC845	Black	27kg (60lbs)	41x41mm (1 <sup>5</sup> / <sub>8</sub> x 1 <sup>5</sup> / <sub>8</sub> " 12 gauge Unistrut®

## Unistrut® & structural ceiling plates

- Attaches directly to standard Unistrut (41x41mm - 1<sup>5</sup>/<sub>8</sub> x 1<sup>5</sup>/<sub>8</sub>" ) or to solid structural ceiling
- Unistrut fittings and attachment hardware sold separately
- For use with Peerless ceiling mounts & projector mounts
- Compatible with Peerless extension poles
- Black finish



### Technical Specifications

Part No.	Colour	Max. weight	Mounting pattern
CMJ300	Black	114kg (250lbs)	104mm spacing between slots
CMJ310	Black	114kg (250lbs)	208mm spacing between slots

## Unistrut® ceiling plate

- For use with 41x41mm (1<sup>5</sup>/<sub>8</sub> x 1<sup>5</sup>/<sub>8</sub>" ) 12 gauge Unistrut
- For use with Peerless ceiling mounts & projector mounts
- Compatible with Peerless extension poles
- Black finish



Technical Specifications			
Part No.	Colour	Max. weight	Mounting pattern
ACC550	Black	114kg (250lbs)	41x41mm (1 <sup>5</sup> / <sub>8</sub> x 1 <sup>5</sup> / <sub>8</sub> " ) 12 gauge Unistrut®

## I-beam clamps

- Adjustable design fits various widths and I-beam thicknesses
- For use with Peerless ceiling mounts & projector mounts
- Compatible with Peerless extension poles
- Black finish



Technical Specifications			
Part No.	Colour	Max. weight	Mounting pattern
ACC558	Black	114kg (250lbs)	102-204mm wide, 6-25mm thick
ACC559	Black	114kg (250lbs)	102-204mm wide, 6-25mm thick

## Truss ceiling plate

- Attaches to round, square, rectangular or I-beam truss up to 76mm wide x 89mm high (3" x 3.5")
- For use with Peerless ceiling mounts & projector mounts
- Compatible with Peerless extension poles
- Black finish



Technical Specifications			
Part No.	Colour	Max. weight	Mounting pattern
ACC557	Black	544kg (1200lbs)	Up to 76mm wide, 89mm high

## Internal joist mount

- Expandable joint mount fits between two wood joists from 16" to 20" centres
- Attachment point for extension pole may be positioned at any point within 70mm (2.75") of either joist
- For use with Peerless ceiling mounts & projector mounts
- Compatible with Peerless extension poles
- Black finish



Technical Specifications			
Part No.	Colour	Max. weight	Mounting pattern
ACC120	Black	136kg (300lbs)	n/a

## Truss ceiling plate with stress decoupler

- Truss ceiling plate with integral high density rubber decoupler to absorb shock
- Attaches to round, square, rectangular or I-beam truss up to 76mm wide x 89mm high (3" x 3.5")
- For use with Peerless ceiling mounts & projector mounts
- Compatible with Peerless extension poles
- Black finish



Technical Specifications			
Part No.	Colour	Max. weight	Mounting pattern
DCT100	Black	136kg (300lbs)	Up to 76mm wide, 89mm high

## Structural ceiling plate with stress decoupler

- Includes structural ceiling plate with integral high density rubber decoupler to absorb shock
- Mounts to concrete beam, slab or other structural member
- For use with Peerless ceiling mounts & projector mounts
- Compatible with Peerless extension poles
- Black finish



Technical Specifications			
Part No.	Colour	Max. weight	Mounting pattern
DCS200	Black	136kg (300lbs)	n/a

# Fixed length extension poles



- For use with Peerless ceiling plates, LCD/Plasma ceiling mounts and projector mounts
- Features safety notches on both ends to prevent accidental loosening of pole
- Extension column lengths measure 89mm (3.5") longer than stated drop to provide finished drop length for various mounts (e.g. EXT101 measures 394mm/15.5")
- Black finish

Technical Specifications			
Part No.	Drop	Colour	Max. weight
EXT002	Flush	Black	544kg (1200lbs)
EXT006	152mm (6")	Black	544kg (1200lbs)
EXT101	305mm (1')	Black	544kg (1200lbs)
EXT103	914mm (3')	Black	544kg (1200lbs)
EXT105	1524mm (5')	Black	544kg (1200lbs)
EXT110	3048mm (10')	Black	544kg (1200lbs)

# Adjustable extension poles



- For use with Peerless ceiling plates, LCD/Plasma ceiling mounts and projector mounts
- Features safety notches on both ends to prevent accidental loosening of pole
- Height adjustment in 25mm (1") increments
- Extension column lengths measure 89mm (3.5") longer than stated drop to provide finished drop length for various mounts (e.g. ADJ012018 measures 394-546mm (15.5-21.5"))
- Black finish

Technical Specifications			
Part No.	Drop	Colour	Max. weight
ADJ012018	305-457mm (1-1.5')	Black	408kg (900lbs)
ADJ018024	457-610mm (1.5-2')	Black	408kg (900lbs)
ADJ0203	610-914mm (2-3')	Black	408kg (900lbs)
ADJ0305	914-1524mm (3-5')	Black	408kg (900lbs)
ADJ0507	1524-2134mm (5-7')	Black	408kg (900lbs)
ADJ0709	2134-2743mm (7-9')	Black	408kg (900lbs)

# Cable management wraps

- Self coiling design securely holds cable along extension pole
- Sections can be stacked to create longer lengths or cut to desired length
- **ACC852**: four 610mm (2') sections
- **ACC856**: four 1829mm (6') sections
- Available in black, silver (-S) or white (-W)



Technical Specifications		
Part No.	Colour	Quantity and length
ACC852	Black	4 x 610mm (2')
ACC856	Black	4 x 1829mm (6')

# Extension pole coupler

- Two female connectors to join two extension columns to create a maximum length of 6m (20')
- For use with Peerless extension columns
- Security screws included



Technical Specifications			
Part No.	Connectors	Colour	Max. weight
ACC109	F to F	Black	544kg (1200lbs)

## Extension pole connectors

- 38mm (1½") access hole for internal cable management
- For use with Peerless extension columns
- Security screws included
- **ACC800** model – one male and one female connection to provide internal cable management between extension column and mount/ceiling plate
- **ACC850** model – two female connectors to provide internal cable management and join two extension columns to create a maximum length on 6m (20')



ACC800



ACC850

### Technical Specifications

Part No.	Connectors	Colour	Max. weight
ACC800	M to F	Black	136kg (300lbs)
ACC850	F to F	Black	136kg (300lbs)

## Threaded connector adaptor

- Threaded adaptor designed to provide compatibility between Paramount LCD and projector mounts (PC930/932, PPA/PPB/PPC), PRS and Peerless extension poles and ceiling plates
- Threaded connector used in ceiling installations to enable the use of multiple ceiling applications such as cathedral ceilings, I-beam and truss
- Increases drop length when used in conjunction with standard extension column
- Available in black, silver (-S) or white (-W) finish



### Technical Specifications

Part No.	Weight capacity
ACC575	36kg (80lbs)

## Escutcheon rings

- Covers hole where extension column passes through ceiling
- Hinged ring wraps around Peerless extension pole
- Available in chrome, black (-B) or white (-W) finish



### Technical Specifications

Part No.	Colour
ACC640	Chrome
ACC640-B	Black
ACC640-W	White

## Armor Lock Plus™ security cable

- Can be used with any projector with a Kensington® slot built into chassis
- Features the Kensington lock with security cable and attachment plate for projector mount



### Technical Specifications

Part No.	Colour	For use with
ACC020	Silver/black	Projector with Kensington® slot

## Safety belt for slotted shelves

- 2.4m (8') belt to secure equipment to shelves with slots
- Tear-resistant nylon



### Technical Specifications

Part No.	Colour	For use with
ACC316	Black	Tray shelf with slots

## Safety belt for AV component shelf

- Safety belt for PS200 AV components shelf (see page 28)
- Holds components in place
- Tear resistant nylon



### Technical Specifications

Part No.	Colour	For use with
ACC322	Black	PS200 component shelf

## Projector wall arm

- Mounts to single wood stud or concrete wall (requires concrete wall plugs, sold separately)
- 362mm (14.25") reach
- Includes flush mount adaptor
- Available in black, silver (-S) or white (-W) finish



### Technical Specifications

Part No.	Colour	Max. weight
PWA-14	Black	23kg (50lbs)

## Side to side adjuster

- For use with extension pole or projector wall arm
- 102mm (4") of radial side to side adjustment
- Includes flush mount tube adaptor
- Black finish



### Technical Specifications

Part No.	Colour	Max. weight
ACC830	Black	23kg (50lbs)

## Extension column stabiliser kit

- Reduces unwanted swaying that may occur with long drop lengths
- For use with Peerless extension columns
- Black finish



### Technical Specifications

Part No.	Colour	Max. weight
ACC050	Black	n/a

## Metal stud wall kit

- For use with SP730P, SA730P, PP730 and PA730 LCD screen mounts when mounting to metal stud (see page 13)
- Includes fasteners to attach wall mount to plate and plate to metal stud wall
- Silver finish



### Technical Specifications

Part No.	Colour	Max. weight
ACC908	Silver	11kg (25lbs)

## Metal stud fastener kits

- For mounting Peerless wall mounts to 25 gauge or heavier metal studs. See mount instructions for appropriate recommendations
- Available with 2, 4, 6 or 50 togglers



### Technical Specifications

Part No.	Colour	No. of togglers
ACC215	Zinc	2
ACC415	Zinc	4
ACC615	Zinc	6
ACC515	Zinc	Pack of 50

## Corner Mount shelf

- For use with CM850, CM50 and CM60 corner mounts (see page 19)
- Creates enclosed compartment when mounted at the bottom of the corner mount
- Top mounting provides open access to AV equipment
- Black finish



### Technical Specifications

Part No.	Colour	For use with	Max. weight
ACC324	Black	n/a	11kg (25lbs)

## Base shelf

- For SR560 LCD/Plasma trolleys (see page 26)
- Additional storage space for PC or larger components
- Designed with slots for safety belt ACC316 (see page 33) to secure equipment
- Black finish



### Technical Specifications

Part No.	Colour	For use with	Max. weight
ACC315	Black	SR560 trolley	23kg (50lbs)

## Video conferencing shelf

- Mounts direct to top of SR560 trolley or SS550P stand (see page 26)
- Adjusts in height along with screen
- Black finish



### Technical Specifications

Part No.	Colour	For use with	Max. weight
ACC319	Black	SR560 trolley SS550P stand	23kg (50lbs)

## Metal shelf

- Metal shelf mounts direct to column of SR560 LCD/Plasma trolleys (see page 26)
- Installs above or below flat panel screen
- Holds AV or computer equipment
- Designed with slots for safety belt ACC316 (see page 33)
- Black finish



### Technical Specifications

Part No.	Colour	For use with	Max. weight
ACC313	Black	SR560 trolley	23kg (50lbs)

## Laptop arm

- Metal shelf mounts direct to column of SR560 LCD/Plasma trolleys (see page 26)
- Supports laptop
- Vertical height and 180° swivel adjustment
- Quick release for easy height adjustment
- Black finish



### Technical Specifications

Part No.	Colour	For use with	Max. weight
ACC314	Black	SR560 trolley SS550P stand	4.5kg (10lbs)

## Tempered glass shelves

- Tempered glass shelf designed to support AV components and accessories
- Attaches directly to SR560 trolleys and SS550P stand (see page 26)



### Technical Specifications

Part No.	Colour	For use with	Max. weight
ACC318-GB	Tinted glass shelf, gloss black brackets	SR560 trolley SS550P stand	23kg (50lbs)

## Equipment accessory shelf

- Accommodates AV components
- Mounts to 89mm (3.5") pole used in Peerless COL series pedestal mounts (see page 27)
- Can be mounted anywhere along the height of the column facing any direction
- Black finish



### Technical Specifications

Part No.	Colour	For use with	Max. weight
ACC833	Black	COL pedestal stand	18kg (40lbs)



Available from:

**peerless®**

**BBG**  
Upgrade your AV experience

© 2009 Peerless Industries Inc. All rights reserved. E&OE  
Selected photography is courtesy of Home Waves Inc.  
All brands, product names and taglines are trademarks or registered trademarks of their respective owners.